

CRT	*C355	*C453
CHUNHWA	1000pFn	330pF
SAMSUNG	—	220pF
GOLD STAR	1000pFn	220pF

PCB-1
 BL5500F01001A-1
 BL5500F01001A-1

3V

Supply Schematic Diagram

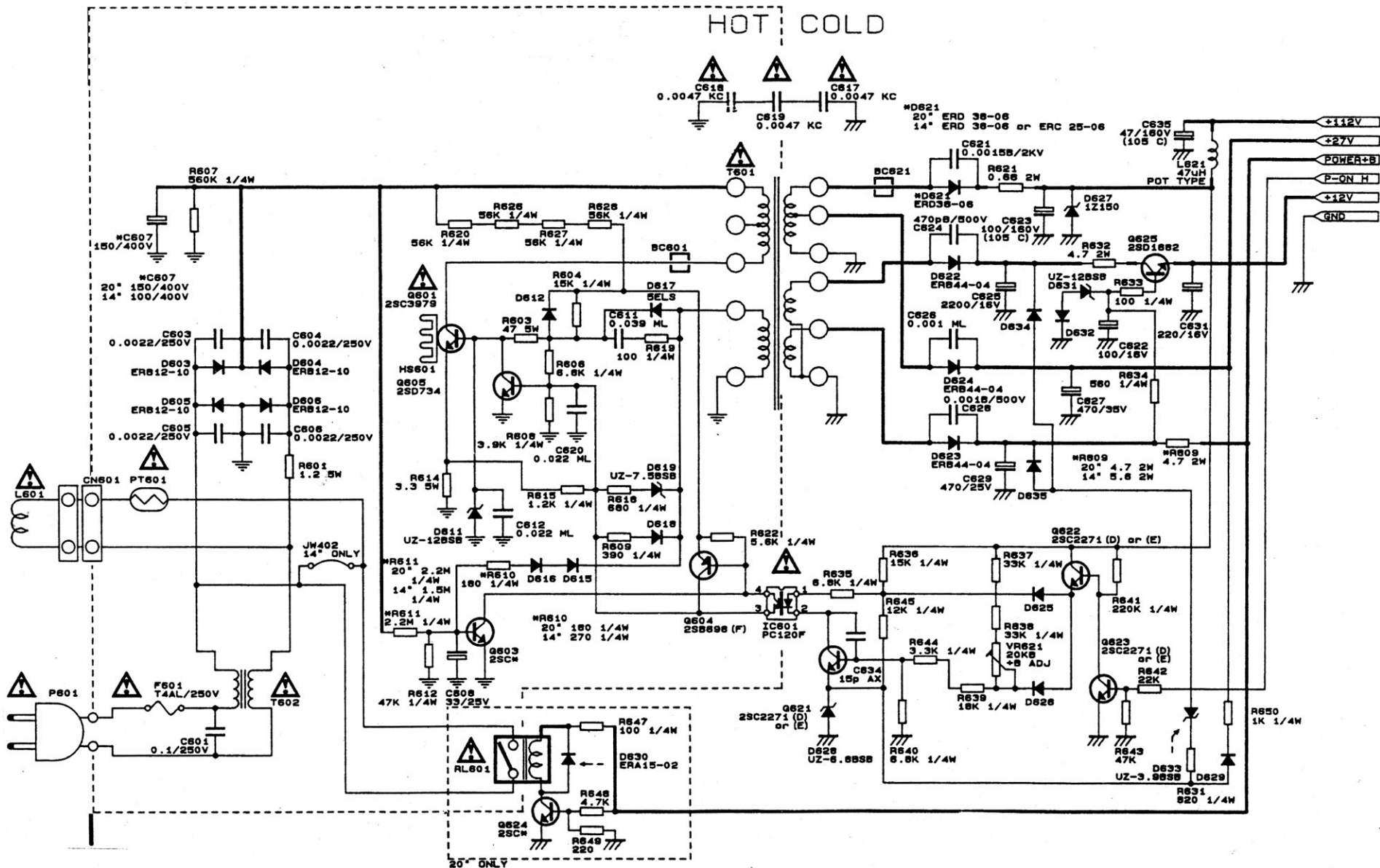

WAVEFORMS

Input: PAL Color Bar Signal (with 1KHz Audio Signal)

Receiving Ch.: E2 ch (48.25MHz)

Preset Mode: Press Picture Select button on the remote control unit, then press the number "1" button.
(Brightness—Center Color—Center Contrast—Approx 70%)

WFa ~ WFt = Waveforms to be observed at Waveform check points. (Shown in Schematic Diagram.)

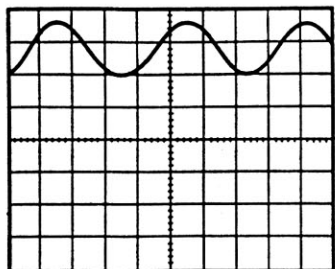

WFa 1DIV: 1V 0.2msec

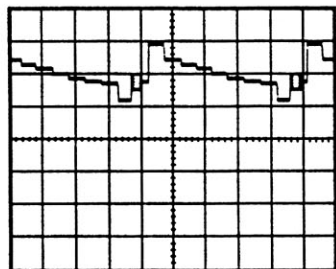

WFe 1DIV: 0.5V 10μsec

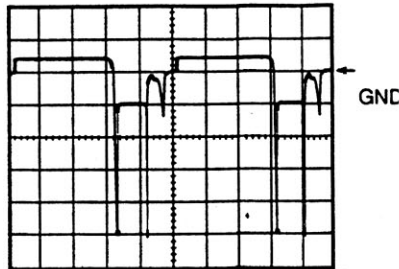

WFi 1DIV: 2V 10μsec

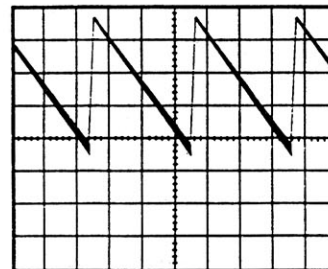

WFn 1DIV: 0.5V 5msec

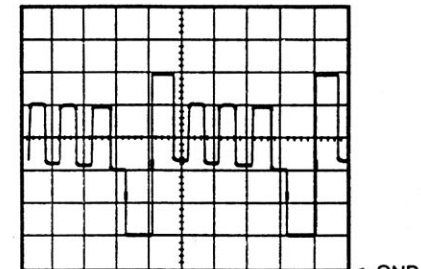

WFq 1DIV: 1V 10μsec

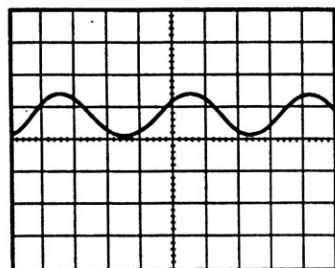

Wfb 1DIV: 1V 0.2msec

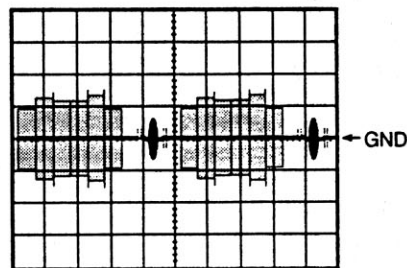

Wff 1DIV: 0.2V 10μsec

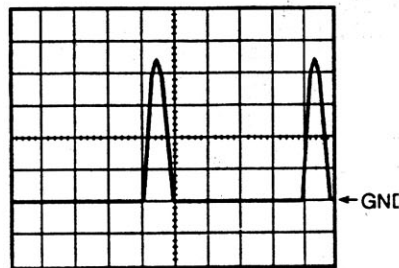

WFj 1DIV: 250V 10μsec

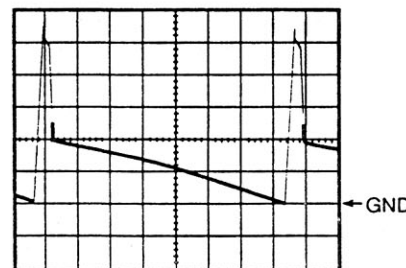

Wfn 1DIV: 10V 2msec

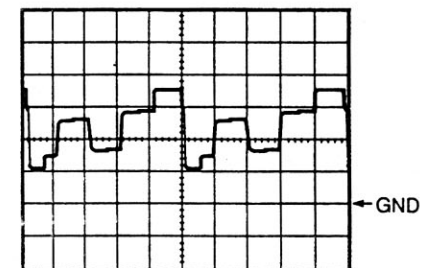

Wfr 1DIV: 50V 10μsec

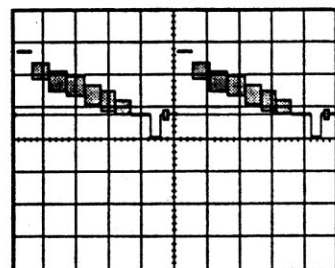

Wfc 1DIV: 1V 10μsec

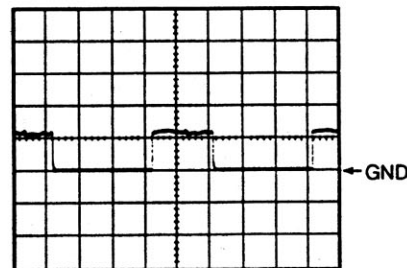

Wfg 1DIV: 0.5V 10μsec

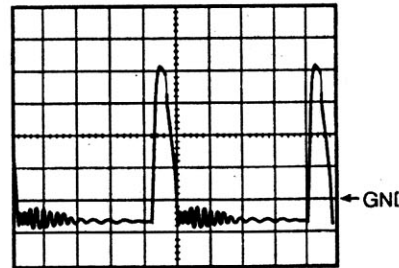

Wfk 1DIV: 5V 10μsec

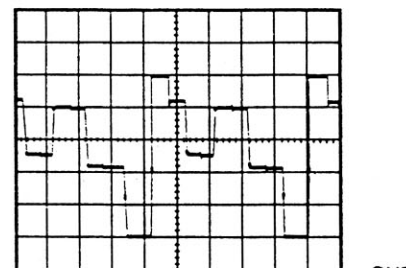

Wfo 1DIV: 1V 10μsec

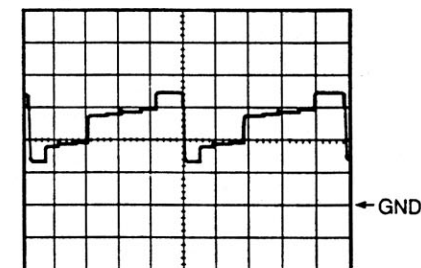

Wfs 1DIV: 50V 10μsec

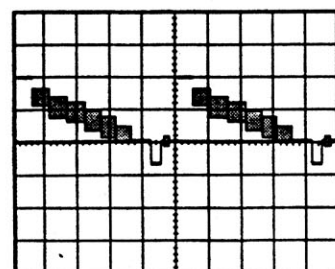

Wfd 1DIV: 1V 10μsec

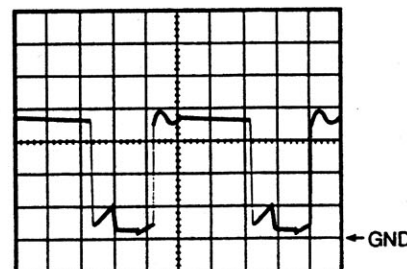

Wfh 1DIV: 50V 10μsec

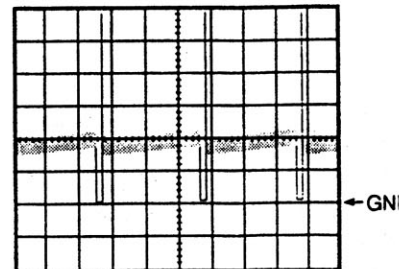

Wfi 1DIV: 0.5V 5msec

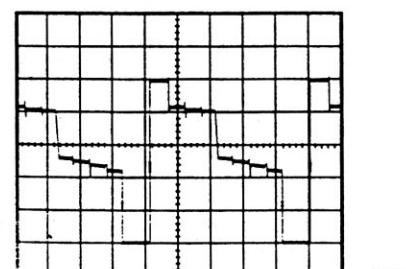

Wfp 1DIV: 1V 10μsec

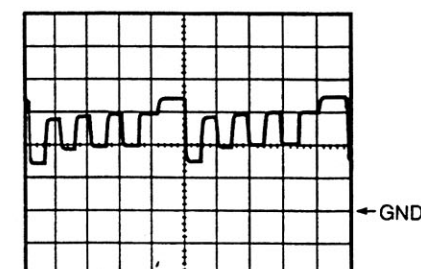

Wft 1DIV: 50V 10μsec